



TPOne-M

Electronic Programmable Room Thermostat
including Domestic Hot Water Timer

Quick Guide **GB**

Guide rapide **FR**

Kurzanleitung **DE**

Guía rápida **ES**

Guida rapida **IT**

Hızlı Kılavuz **TR**

Hurtig Guide **DK**

Full product instructions can be found at:

[FR] Des instructions complètes des produits sont consultables à :

[DE] Die vollständigen Produktinformationen können abgerufen werden auf:

[ES] Las instrucciones completas de producto se pueden encontrar en:

[IT] Le istruzioni complete del prodotto sono disponibili all'indirizzo:

[TR] Ürünle ilgili tüm talimatlar şurada bulunabilir:

[DK] Der findes en fuld produktvejledning på:

www.guides-tpone.danfoss.com

ErP Class		
The products represented within this document are classified according to, and allow completion of, the Energy Related Product (ErP) Directive System Package fiche and the ErP system data label. ErP Labelling obligation is applicable from 26th September 2015.		
ErP Class	Product Function and ErP Description	Additional efficiency gain
IV	<p>TPI Room Thermostat, for use with on/off output heaters</p> <p>An electronic room thermostat that controls both thermostat cycle rate and in-cycle on/off ratio of the heater proportional to room temperature. TPI control strategy reduces mean water temperature, improves room temperature control accuracy and enhances system efficiency.</p>	2%
	<p>[FR] Thermostat d'ambiance TPI, à utiliser avec des radiateurs à sortie de type marche/arrêt</p> <p>[DE] TPI-Raumthermostat zur Verwendung mit Ein-/Aus-Ausgangsheizsystemen</p> <p>[ES] Termostato de ambiente TPI, para uso con calentadores de encendido y apagado según demanda</p> <p>[IT] Termostato d'ambiente con funzione TPI, destinato all'uso con apparecchi di riscaldamento con uscita ad accensione/spengimento</p> <p>[TR] Açma/kapama çıkışlı ısıtıcılarla kullanılm için TPI Oda Termostatı</p> <p>[DK] TPI-rumtermostat, til anvendelse sammen med til/fra-effektvarmere</p>	



This product complies with the following EU Directives:
 Electromagnetic Compatibility
 2014/30/EU
 Low Voltage
 2014/35/EU
 Restriction of the use of certain Hazardous Substances
 2011/65/EU



Danfoss can accept no responsibility for possible errors in catalogues, brochures, and other printed material. All trademarks in this material are property of the respective companies. Danfoss and the Danfoss logotype are trademarks of Danfoss A/S. All rights reserved.

Installation Instructions

Please note: This product should only be installed by a qualified electrician or competent heating installer and should be in accordance with local wiring regulations.

[FR] Remarque : ce produit doit être installé exclusivement par un électricien qualifié ou un chauffagiste compétent et doit être conforme à la version en vigueur des réglementations de câblage locales.

[DE] Bitte beachten: Dieses Produkt darf nur von einer Elektrofachkraft oder einem qualifizierten Heizungsinstallateur gemäß der aktuellen Ausgabe der VDE-Elektroinstallationsrichtlinien installiert werden.

[ES] Nota: La instalación de este producto solo puede ser llevada a cabo por electricistas cualificados o instaladores de calefacción formados, de conformidad con la normas de cableado locales.

[IT] NB: questo prodotto deve essere installato solo da un elettricista qualificato o da un installatore riscaldamento competente, in conformità delle norme di cablaggio locali.

[TR] Lütfen Dikkat: Bu ürün yalnızca yetkili bir elektrikçi ya da yetkin bir ısıtma kurulumcusu tarafından kurulmalı ve elektrik tesisatı düzenlemelerinin geçerli sürümüne uygun olmalıdır.

[DK] Bemærk: Dette produkt må kun installeres af en autoriseret elektriker eller en faglært varmeinstallatør og skal overholde de lokale regler og bestemmelser vedrørende.

Thermostat or Remote Room Sensor positioning:

[FR] Positionnement d'un thermostat ou d'une sonde d'ambiance à distance :

[DE] Positionierung des Thermostats oder Raumfernfühlers:

[ES] Colocación del termostato o del sensor de ambiente remoto:

[IT] Posizionamento termostato o sensore ambiente remoto:

[TR] Termostat veya Uzak Oda Sensörünü konumlandırma:

[DK] Placering af termostat eller ekstern rumføler:

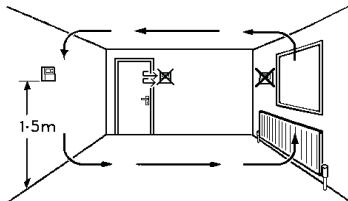

Mounting

[FR] Montage

[IT] Montaggio

[DE] Montage

[TR] Montaj

[ES] Montaje

[DK] Montering

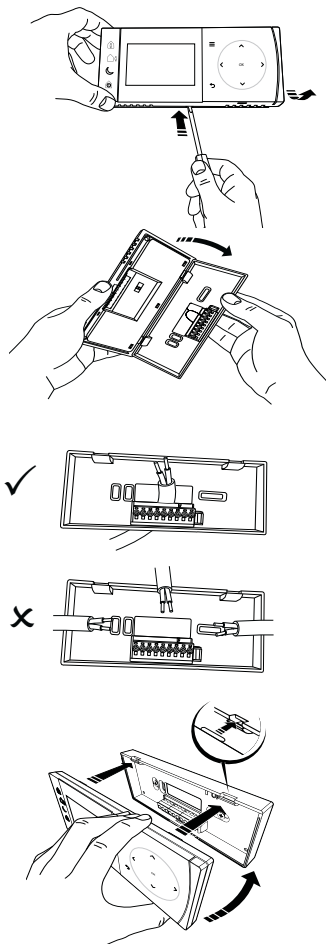

Wiring

[FR] Câblage	[IT] Cablaggio
[DE] Verdrahtung	[TR] Elektrik şebekesi
[ES] Alambrado	[DK] Ledningsføring

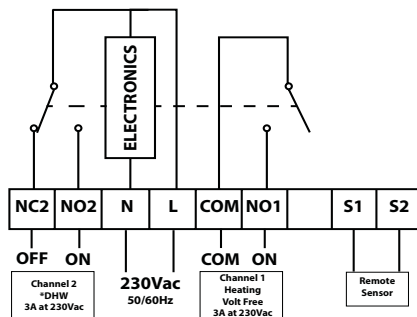

* Domestic hot water, optional timed output only

[FR] Eau chaude sanitaire, sortie programmée optionnelle uniquement
[DE] Trinkwarmwasser, optional nur mit zeitlich gesteuerter Leistung
[ES] Agua caliente sanitaria, solo salida programada opcional
[IT] Solo acqua calda sanitaria, uscita temporizzata opzionale
[TR] Sadece evsel sıcak su, isteğe bağlı zamanlı çıkış
[DK] Kun varmt brugsvand, valgfri tidsindstillet udgang

Remote sensor inputs

[FR] Entrées de capteurs à distance	[IT] Ingressi sensore remoto
[DE] Eingang für entfernte Sensoren	[TR] Oda Sensör Bağlantıları
[ES] Entrada para sensor externo	[DK] Ekstern sensorindgang

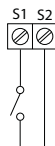
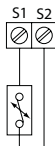

Remote room or limit sensor

[FR] Capteur d'ambiance à distance ou pour capteur de limite
[DE] Fernfühler oder Grenzwertsensor
[ES] Sensor externo de ambiente o sensor de límite de temperatura
[IT] Sensore limite o ambiente remoto
[TR] Oda sensörü veya limit sensörü
[DK] Ekstern rumssensor eller grænseføler

Window switch contact

[FR] Interrupteur de contact de fenêtre
[DE] Fensterschalterkontakt
[ES] Contacto de interruptor de ventana
[IT] Contatto finestra
[TR] Pencere anahtarı kontağı
[DK] Vindueskontakt

User Interface

[FR] Interface utilisateur	[IT] Interfaccia utente
[DE] Bedienoberfläche	[TR] Kullanıcı Arabirimi
[ES] Interfaz de usuario	[DK] Brugergrenseflade

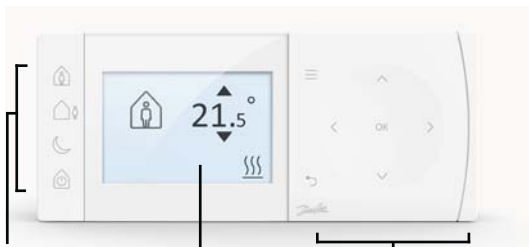

Comfort modes

[FR] Modes de confort
[DE] Komfortmodi
[ES] Modos confort
[IT] Modalità comfort
[TU] Konfor modu
[DK] Komforttilstande

Display

[FR] Affichage
[DE] Display
[ES] Pantalla
[IT] Display
[TU] Ekran
[DK] Display

Navigation

[FR] Navigation
[DE] Menü
[ES] Navegación
[IT] Navigazione
[TU] Navigasyon
[DK] Navigation

	Home	- Accueil - Zu Hause - En Casa	- In Casa - Eyde - Hjemme
	Away	- Absence - Abwesend - Ausente	- Fuori Casa - Dışanda - Ikke til stede
	Asleep	- Nuit - Schlafend - Dormido	- Addormentato - Uyku - Sover
	Standby	- Veille - Standby - En Espera	- Standby - Bekleme - Standby
	Menu	- Menu - Menu - Menü	- Menu - Menüü - Menu
	Select / Confirm	- Sélectionner/ confirmer - Auswählen/ Bestätigen - Seleccionar/ Confirmar	- Selezionare/ Confermare - Seç / Onayla - Vælg/bekræft
	Menu Back	- Retour au menu - Menü Zurück - Menü atrás	- Menu indietro - Menüye Geri Dön - Menu tilbage
	Navigation	- Navigation - Menü - Navegación	- Navigazione - Navigasyon - Navigation

Display

[FR] Affichage

[IT] Display

[DE] Display

[TR] Ekran

[ES] Pantalla

[DK] Display

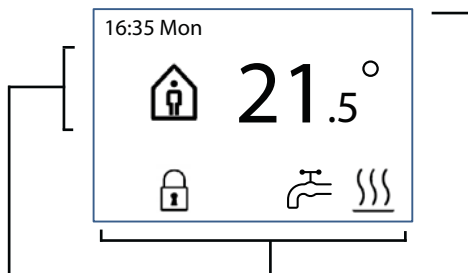

Info & Settings

[FR] Informations et réglages

[DE] Info & Einstellungen

[ES] Información y ajustes

[IT] Info e impostazioni

[TU] Bilgi ve Ayarlar

[DK] Info & indstillinger

Status Icons

[FR] Icônes d'état

[DE] Statussymbole

[ES] Iconos de estado

[IT] Icone di stato

[TU] Durum Simgeleri

[DK] Statusikoner

Dates & Warnings

[FR] Dates et avertissements



[DE] Daten & Warmmeldungen

[ES] Fechas y advertencias

[IT] Date e avvertenze

[TU] Tarihler ve Uyarılar

[DK] Datoer & advarsler

	Button Lock	- Bouton de verrouillage - Tastensperre - Bloqueo del botón	- Blocco pulsante - Buton Kilidi - Tastatur Lås
	Heat Calling	- Demande de chaleur - Wärmeanforderung - Solicitud de calor	- Calling calore - Isı Arama - Varmeaktivering
	Hot Water	- Eau chaude - Warmwasser - Agua caliente	- Acqua calda - Sıcak Su - Varmt vand

Setup Wizard

[FR] Assistant de configuration

[IT] Configurazione guidata

[DE] Einrichtungsassistent

[TR] Kurulum Sihirbazı

[ES] Asistente de configuración

[DK] Installationsguide

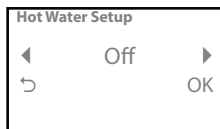
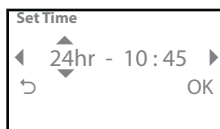
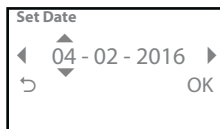
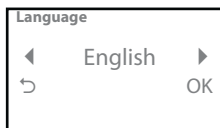
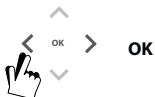

READY

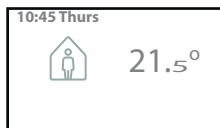

Set Temperatures

[FR] Réglage des températures

[IT] Impostazione temperatura

[DE] Temperaturen einstellen

[TR] Sıcaklık Ayarlama

[ES] Ajuste de temperaturas

[DK] Indstilling af temperaturer

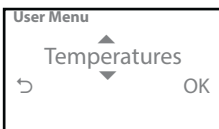
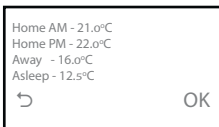
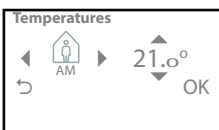
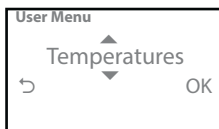
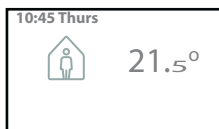

Setup Schedule

[FR]	Planning de programmation	[IT]	Programma di setup
[DE]	Einrichtungsplan	[TR]	Kurulum Programı
[ES]	Configuración de la programación	[DK]	Opsætning af tidsplan

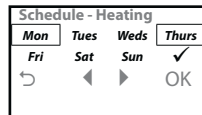
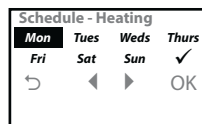
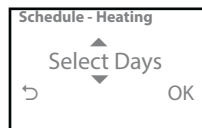
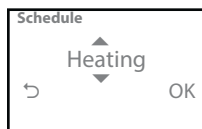
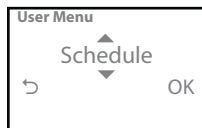
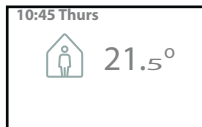

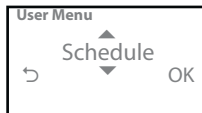
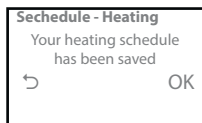
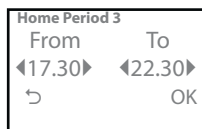
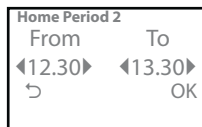
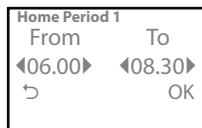
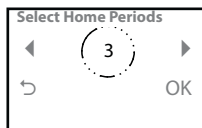

User Menu

[FR]	Menu utilisateur	[IT]	Menu utente
[DE]	Benutzermenü	[TR]	Kullanıcı Menüsü
[ES]	Menú de usuario	[DK]	Brugermenu

Hot Water	- Eau chaude - Warmwasser - Agua caliente	- Acqua calda - Sıcak Su - Varmt vand
Click & Save	- Cliquer et économiser - Klicken & Sparen - Clic para ahorrar	- Click e risparmio - Tıkla & Kaydet - Klik og spar
Heating Mode	- Mode de chauffage - Heizbetriebe - Modo Calefacción	- Modalità de Riscald - Isıtma Modu - Varmestyring
Schedule	- Programme - Zeitplan - Programación	- Pianificazione - Plan - Program
Temperatures	- Températures - Temperaturen - Temperaturas	- Temperature - Sıcaklıklar - Temperaturer
Holiday	- Vacances - Ferien - Vacaciones	- Vacanza - Tatil - Ferie

User Settings

[FR]	Réglages utilisateur	[IT]	Impostaz. utente
[DE]	Benutzereinstellungen	[TR]	Kullanıcı Ayarları
[ES]	Ajustes de usuario	[DK]	Brugerindstillinger

Set Date	- Réglage date - Einstellen des Datums - Configuración de fecha	- Imposta data - Tarihi Ayarlayın - Indstil dato
Set Time	- Réglage heure - Einstellen der Zeit - Configuración de hora	- Imposta ora - Saati Ayarlayın - Indstil klokkeslæt
Button Click	- Bouton de sélection - Schaltflächen - Clic del botón	- Pulsante di Clic - Tıkla Butonu - Tastatur Klik
Backlight	- Rétroéclairage - Hintergrundbeleuchtung - Retroiluminación	- Retroilluminazione - Arka Işık - Baggrundsbelysning
Temperature Scale	- Échelle de température - Temperaturbereich - Escala de temperatura	- Scala della temperatura - Sıcaklık Skalası - Temperatur enhed
Language	- Langue - Sprache - Idioma	- Lingua - Dil - Sprog
User Reset	- Réinitialisation - Reset durch Benutzer - Reinicio del usuario	- Reset utente - Kullanıcı Sıfırlama - Bruger reset
Information	- Information - Infos - Información	- Informazioni - Bilgi - Information

Installer Settings

[FR]	Réglages installateur	[IT]	Impostazioni di installazione
[DE]	Installateureinstellungen	[TR]	Kurulumcu Ayarları
[ES]	Ajustes del instalador	[DK]	Installatørindstillinger

Hot Water Setup	- Configuration Eau Chaude - Warmwasser Einstellung - Configuración Agua Caliente	- Configurazione Acqua Calda - Sıcak Su Kurulumu - Opsætning af Varmt Vand
Control Type	- Type de contrôle - Regelungstyp - Tipo de Control	- Tipo di Controllo - Kontrol Tipi - Regulerings type
Start-up Method	- Méthode de démarrage - Aufheizverfahren - Método de arranque	- Tipo di avvio riscald - Başlatma Yöntemi - Opvarmningsmetode
Temperature Limits	- Limites de température - Temperaturgrenzen - Límites de temperatura	- Limiti temperatura - Sıcaklık Limitleri - Temperaturgrænser
Frost Protect	- Protection contre le gel - Frostschutz - Protección antiescarcha	- Protezione antigelo - Donma Koruması - Frostbeskyttelses
Temperature Override	- Surpassement - Temp.übersteuerung - Anulación de temperatura	- Cambio manuale temp. - Sıcaklığı Geçersiz Kil - Manuelle temp. grænser
Daylight Saving	- Heure d'été - Sommerzeit - Horario de verano	- Ora legale - Yaz Saati - Sommertid
Button Lock	- Bouton de verrouillage - Tastensperre - Bloqueo del botón	- Blocco pulsanti - Buton Kilidi - Tastatur Lås
Display Idle Mode	- Mode écran de veille - Display Ruhemodus - Pantalla en modo Reposo	- Modalità display inattivo - Görüntü Bekleme Modu - Inaktivt display
External Sensor	- Sonde externe - Externer Temperaturfühler - Sensor externo	- Sensore esterno - Harici Sensör - Ekstern føler
Service Interval	- Intervalle de maintenance - Serviceintervall - Intervalo de mantenimiento	- Intervallo di manutenzione - Servis Aralığı - Serviceinterval
Service Demo	- Démo Service - Service-Demo - Demo de mantenimiento	- Demo di servizio - Servis Demosu - Service-demo
Installer Lock	- Verrouillage installateur - Installateursperre - Bloqueo del instalador	- Blocco installatore - Kurulumcu Kilidi - InstallatörLås
Installer Reset	- Réinitialisation - Installateur Reset - Reinicio del instalador	- Reset installatore - Kurulumcu Sıfırlaması - Installatør reset

Information and Warnings

[FR]	Informations et avertissements	[IT]	Informazioni e avvertenze
[DE]	Informationen und warnungen	[TR]	Bilgi ve Uyarılar
[ES]	Información y advertencias	[DK]	Information og advarsler

Window Open	- Fenêtre ouverte - Fenster offen - Ventana abierta	- Finestra aperta - Açık Pencere - Åbent vindue
Product Lock	- Verrouillage - Heizungssperre aktiv - Bloqueo del dispositivo	- Prodotto bloccato - Ürün Kilidi - Varmespærring aktiv
Optimised Start	- Démarrage anticipé - Optimierter Start - Inicio optimizado	- Avviamento ottimale - İdeal Başlangıç - Optimeret Start
Delayed Start	- Démarrage retardé - Verzögerter Start - Arranque retardado	- Avviamento ritardato - Geciktirilmiş Başlangıç - Forsinket start
Frost Risk	- Risque de gel - Frostgefahr - Riesgo de congelación	- Rischio di congela - Donma Riski - Risiko for frysning
Low Heat	- Chauffage bas - Heizung ausgefallen - Calefacción baja	- Basso calore - Düşük Sıcaklık - Manglende varme
Service Due	- Interval de service - Service fällig - Revisé dispositivo	- Servizio dovuto - Servis Zamanı - Tid til service
Heat Reduced	- Chauffage limité - Heizleistung begrenzt - Calefacción reducida	- Riduzione del riscald. - Sıcaklık Düşümü - Varme begrænset
High Floor Temperature	- Température sol élevée - Hohe Bodentemperatur - Temp de suelo alta	- T. elevata del pavimento - Yüksek Akış Sıcaklığı - Høj gulvtemperatur
Sensor Fail	- Défaut sonde - Fühler ausgefallen - Fallo sensor	- Guasto sensore - Sensör Hatası - Fejl på føler
External Sensor Fail	- Défaut sonde extérieure - Raumfühler ausgefallen - Fallo sensor exterior	- Guasto sens. esterno - Harici Sensör Arızası - Fejl på rumføler
Floor Sensor Fail	- Défaut sonde sol - Bodenfühler ausgefallen - Fallo sensor suelo	- Guasto sens. pavimento - Akış Sensörü Arızası - Fejl på gulvføler

ENGINEERING
TOMORROW



Danfoss Ltd.

Amphill Road
Bedford MK42 9ER

Tel: 01234 364621

Fax: 01234 219705

Email: ukheating@danfoss.com

Website: www.heating.danfoss.co.uk